

LATERAL OPENING DOOR SYSTEM

FAD-54 / FAD-54L

SLIDING & FOLDING DOOR HARDWARE



Handle on picture sold separately. (Item No. : XLA-HH series)

MonoFlat FAD™

Item No.	FAD-54	FAD-54L
Door Width	800~850 mm (31-1/2"~33-15/32")	
Door Height	Max. 2380 mm (93-11/16")	Max. 2980 mm (117-5/16")
Door Thickness	24~38 mm (61/64"~1-1/2")	
Door Weight	Max. 35 kg (77 lbs)/Door	

*In case of 25mm (1") overlay.

- Other "MonoFlat series" available.
 - MonoFlat FAD-5 For door weight 5 kg (11 lbs) – P.599
 - MonoFlat FAD-20 For door weight 20 kg (44 lbs) – P.600~601
 - MonoFlat LIN-X For door weight 24 kg (53 lbs) – P.592~597
 - MonoFlat Unison For door weight 30 kg (66 lbs) – P.558~559

LATERAL OPENING DOOR SYSTEM

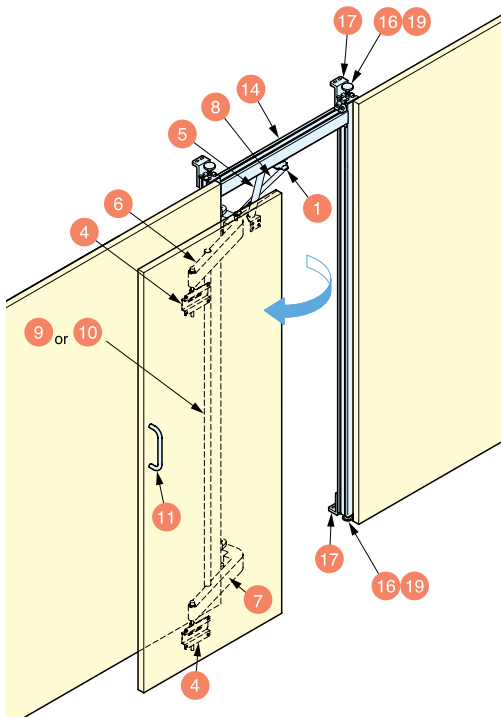

- Flush Surface
Designed to close flush against surrounding walls, providing clean appearance.
- Lateral Opening Mechanism
Allows doors to swing out laterally in a small radius, ideal for tight front space application.
- Aluminum frame supplied for durable construction
- No rails or bottom guide required
- Smooth Movement
Built-in gas spring provides a smooth self opening & closing movement.
- Height adjustable by cutting arm connecting pipe
- Various applications
Can be used in single or double door configuration. Ideal for walk-in closets, partitions, hidden door applications etc.

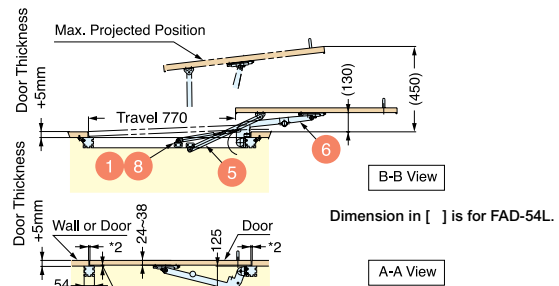

Dimension in [] is for FAD-54L.

Various Opening Configurations

Left Hand Use



Right / Left Combinations



Right Hand Use



*1 Vertical frame or door stoppers on floor for both doors required in center.



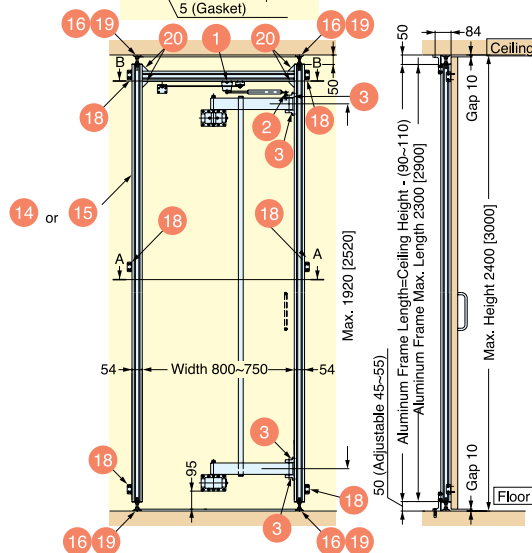
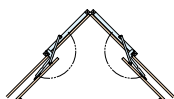

Corner Use







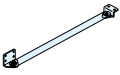
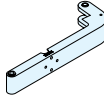
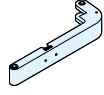
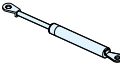
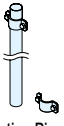
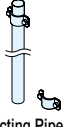

*2 Min.4mm gap on both side of door.

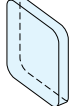
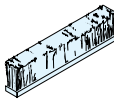
Parts Set (per door)		Necessary Parts	
Item No.	Door Height	Description	
FAD-54	Max. 2380 mm (93-11/16")	Please see Qty a	
FAD-54L	Max. 2980 mm (117-5/16")	Please see Qty b	

Parts Included

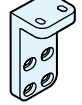
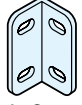
No.	Qty		Part Name	Description
	a	b		
1	1pc	1pc	 Gas Spring Bracket <ul style="list-style-type: none"> Material/Steel Finish/Clear Zinc Chromate 	
2	1pc	1pc	 Screw Pin <ul style="list-style-type: none"> Material/Steel Finish/Clear Zinc Chromate 	
3	4pcs	4pcs	 Bearing Housing <ul style="list-style-type: none"> Material/Aluminum Finish/Color - Silver 	
4	2pcs	2pcs	 Arm Bracket <ul style="list-style-type: none"> Material/Steel, Polyacetal Finish/Color - Silver 	
5	1pc	1pc	 Support Arm <ul style="list-style-type: none"> Material/Steel, Polyacetal Finish/Color - Silver 	
6	1pc	1pc	 Upper Arm <ul style="list-style-type: none"> Material/Aluminum Finish/Color - Silver 	
7	1pc	1pc	 Bottom Arm <ul style="list-style-type: none"> Material/Aluminum Finish/Color - Silver 	
8	1pc	1pc	 Gas Spring <ul style="list-style-type: none"> Color/Grey 	
9	1set	-	 Connecting Pipe & Clamp <ul style="list-style-type: none"> Material/Steel Finish/Color - Silver 1990 mm 	
10	-	1set	 Connecting Pipe & Clamp <ul style="list-style-type: none"> Material/Steel Finish/Color - Silver 2600 mm 	

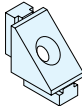
No.	Qty		Part Name	Description
	a	b		
11	1pc	1pc	 Handle <p style="color: red; font-weight: bold; text-align: center;">Not Included</p> <ul style="list-style-type: none"> Material / 304 Stainless Steel Finish / Mirror 	
12	1pc	1pc	 Bumper <ul style="list-style-type: none"> Material/Polyurethane Finish/Clear 	
13	1pc	1pc	 Strip Brush <ul style="list-style-type: none"> Color/Grey 	
14	V 2pcs	-	 Alum. Frame (FAD-54) (V2300mm, H800mm) <ul style="list-style-type: none"> Material/Aluminum Finish/Anodized 	
15	-	V 2pcs	 Alum. Frame (FAD-54L) (V2900mm, H800mm) <ul style="list-style-type: none"> Material/Aluminum Finish/Anodized 	
16	4pcs	4pcs	 Glide Base <ul style="list-style-type: none"> Material/Steel Finish/Color - Silver 	
17	4pcs	4pcs	 Frame Bracket <ul style="list-style-type: none"> Material/Aluminum Finish/Color - Silver 	
18	6pcs	6pcs	 Angle Connector <ul style="list-style-type: none"> Material/Steel Finish/Clear Zinc Chromate 	
19	4pcs	4pcs	 Leveling Glide <ul style="list-style-type: none"> Material/Steel, Elastomer Finish/Color <ul style="list-style-type: none"> Clear Zinc Chromate Black 	
20	8pcs	8pcs	 Frame Connector <ul style="list-style-type: none"> Material/Aluminum, Zinc Alloy Finish/Silver, Chromate 	